

Numerical simulation of coastal erosion and its mitigation by living shoreline methods: A case study in southern Rhode Island

By

Scott Hayward¹, M. Reza Hashemi^{2*}, Marissa Torres², Annette Grilli², Stephan Grilli², John King³, Chris Baxter², and Malcolm Spaulding²

1) Ransom Consulting Inc., 400 Commercial Street, Portland, ME 04101;

2) Department of Ocean Engineering, University of Rhode Island, Narragansett, RI 02882, USA;

3) Graduate School of Oceanography, University of Rhode Island, Narragansett, RI 02882, USA;

* Corresponding author: Email reza_hashemi@uri.edu

ABSTRACT

Accelerated shoreline retreat due to sea level rise is a major challenge for coastal communities in many regions of the U.S. and around the world. While many methods of erosion mitigation have been empirically tested, and applied in various regions, more research is necessary to understand the performance of these mitigation measures using process-based numerical models. These models can potentially predict the response of a beach to these measures and help identify the best method. Further, because nearshore sediment transport processes are still poorly understood, there are many uncertainties in assessment of coastal erosion and mitigation measures. Hence, there is a need to better assess the capabilities and shortcomings of numerical models as a way to improve them. In this work, a suite of numerical models was used to assess coastal erosion and the performance of a number of recommended solutions, along a section of coast in southern Rhode Island, US, which represents a typical coastal barrier system. The coupled modeling system SWAN (Simulating Waves Nearshore), a third-generation wave model, and ADCIRC (ADvanced CIRCulation Model), a two-dimensional depth integrated circulation model, was applied over a regional grid encompassing northeastern U.S. to compute offshore sea levels and wave conditions for specified storm scenarios, both historical and synthetic. The coastal wave-circulation and morphodynamic model XBeach was then

nested within this regional grid to simulate nearshore sediment transport processes and shoreline erosion. After validating the regional modeling system for a historical storm (Hurricane Sandy), Hurricane Irene (2011) was used to validate XBeach, on the basis of a unique dataset of pre- and post-storm beach profiles that was collected in our study area for this event. XBeach showed a relatively good performance, being able to estimate eroded volumes along three beach transects within 8% to 39%, with a mean error of 23%. The validated model was then used to analyze the effectiveness of three living shoreline erosion mitigation methods that were recommended in a recent study of coastal erosion in New England: beach nourishment, coastal bank (engineered core), and submerged breakwater. Further, the effect of an artificial surfing reef on sediment transport was also investigated. Conceptual designs were implemented in the model and the eroded volume were computed, with and without the presence of these solutions. Using two synthetic storms, it was shown that erosion mitigation methods that focus on reinforcing the beach face and dunes are more effective than those that reduce wave action. While this study showed how models such as XBeach can help examine the technical performance of erosion mitigation measures, more detailed assessments including cost-benefit analyses are necessary at the decision-making level.

Coastal communities on the East Coast of the United States (US) are likely to experience a greater impact from tropical storms in the future.¹ In addition to sea level rise (SLR), a number of studies have related climate change to an increase in the number of higher intensity tropical storm activity (Holland and Bruyere 2014; Yoshida *et al.* 2017). Along the barrier beaches and barrier islands bordering the U.S. East Coast, severe storms often cause widespread dune and beach erosion, resulting in beach recession and damage to infrastructure. As beaches erode, the natural protection they provide to coastal

ADDITIONAL KEYWORDS: XBeach, ADCIRC, SWAN, living breakwater, beach nourishment, geotextile bank protection, recreational surfing reef.

Manuscript submitted 13 July 2018, revised and accepted 19 October 2018.

infrastructure is gradually reduced. With the perspective of increasing damage from the combination of more severe storms and SLR, coastal communities, particularly along the U.S. East Coast, must adapt and increase their resilience to these natural disasters.

In the wake of superstorm Sandy (2012) and the widespread damage it

caused to coastal communities along the upper U.S. East Coast, the U.S. Army Corps of Engineers (USACE) performed the North Atlantic Coastal Comprehensive Study (NACCS; Jensen *et al.* 2016), which assessed resilience and adaptation in the face of increased risk to ports, coastal communities, and businesses. As part of this study, both storm surge and waves were modeled for 1,050 synthetic tropical and 100 historical extratropical storms. Results of these simulations were used to assess the vulnerability of the U.S. East Coast to storms and SLR, and propose solutions to increase coastal resilience. Although NACCS results were reasonably well validated in offshore regions, some studies have shown that these results were not as accurate in near-

1) For more details visit the ongoing research at NOAA's GFDL lab: <http://www.gfdl.noaa.gov/global-warming-and-hurricanes>.

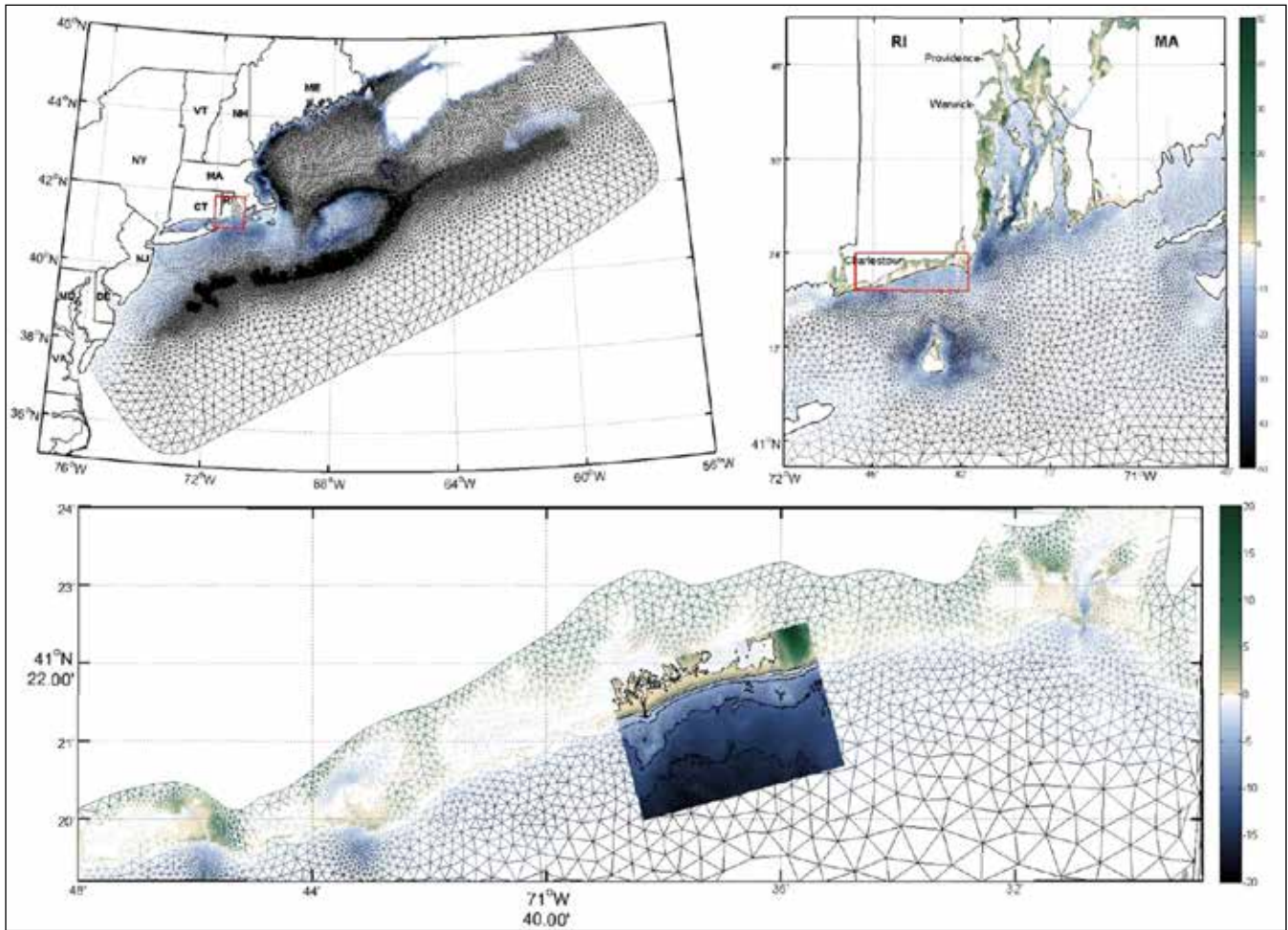

Figure 1. Computational domains of the study. Unstructured regional SWAN+ADCIRC mesh that covers the northeastern U.S. is shown in the top panel. The extent of the nearshore XBeach model in southern coast of Rhode Island is highlighted in the bottom panel.

shore regions and around barrier beach systems (Shaw *et al.* 2016). Nevertheless, both the synthetic tropical and historical extratropical storms from NACCS can be useful to set up more accurate nearshore models to estimate nearshore wave and storm surge conditions.

With over 300 miles of mostly erodible sandy coastline, the state of Rhode Island (RI) in the Northeast of the U.S. is threatened by both tropical and extratropical storms. Barrier beach systems (i.e. coastal ponds protected by barrier beaches, often confined between headlands) make up much of the southern RI coast and are especially vulnerable to breaching and overtopping due to a combination of storm waves and surge. Coastal communities such as Charlestown, Matunuck, Misquamicut, and Quonochontaug, RI, are located on and around barrier beach systems, which recent studies have shown are experiencing a trend of increased coastal erosion (Boothroyd *et al.* 2016). Shaw *et al.* (2016) showed if dunes in

these systems were significantly eroded, flooding extent during an event similar to Hurricane Bob (1991) would increase by 200%, because natural dunes are the main protection against coastal flooding in barrier beach systems. Schambach *et al.* (2018) recently used the coastal wave/circulation and geomorphodynamic model XBeach to simulate erosion of the Charlestown, RI barrier beach system during Irene (2011) and for a synthetic 100-year tropical storm. This study showed the effect of a dune system in reducing coastal flooding and also the important role of coastal vegetation in mitigating dune erosion. Therefore, there is a growing interest to protect and restore these valuable natural resources, which has led many of the barrier systems along the southern coast of Rhode Island to be designated as coastal barrier resource systems.²

Regulations in several states, including North Carolina and RI, prohibit using “hard” coastal protection structures (https://www.fws.gov/CBRA/).

tures such as breakwaters, seawalls, and similar structures and promote less invasive quasi-natural protection methods (Zeitlin-Hale *et al.* 2010). Besides beach re-nourishment, such methods include dune restoration and using endemic plants to reinforce the dunes. Narragansett town beach is one example of a RI beach community actively making efforts to maintain the coastline by restoring dunes and regularly re-nourishing the most eroded sections of the beach (Woods Hole Group 2011). The Woods Hole Group (2017) recently conducted a coastal resilience study under the auspice of the Northeastern Regional Association of Coastal Ocean Observing Systems (NERACOOS). As part of that effort, they proposed simple tools and methodologies for most effectively increasing coastal resilience in New England. In particular, these tools can help determine the most effective approach for mitigating erosion in specific cases, based on a number of factors such as wave climate, available resources, tidal

range, and beach slope. Additionally, the tools can help decision-makers rule out the less effective approaches.

Large-scale erosion mitigation projects can be costly to develop and implement. These projects are often recommended based on the success or failure of previous applications. Hence, for a case study, it is advantageous to use numerical models to assess the performance of potential erosion mitigation methods, and reduce uncertainty before selecting and further analyzing a design. As an illustration of this approach, in this work, we apply a suite of state-of-the-art numerical models to simulate the erosion of a barrier beach system in southern RI due to extreme storm surge and waves. We then perform additional simulations to assess and compare the performance of several conceptual living shoreline designs. Results and methodologies used in this work could be beneficial to similar case studies, particularly in areas that are protected by coastal barrier systems.

METHODOLOGY

Numerical models

Two numerical models are used in this work (Figure 1): (1) a coupled wave-storm surge model SWAN-ADCIRC (Booij *et al.* 1999; Dietrich *et al.* 2011; Luetlich *et al.* 1992) was applied over a large unstructured triangular regional grid. This model was forced by hurricane wind fields to simulate offshore waves and storm surge caused by specific storms. (2) a hydrodynamic and morphodynamic model XBeach (Roelvink *et al.* 2009) was then applied over a high-resolution near-shore Cartesian grid to simulate nearshore hydrodynamics, sediment processes and coastal erosion.

The unstructured regional grid (Figure 1) was developed by re-meshing the NECOFS Gulf of Maine (GOM4) grid (Chen *et al.* 2006) along the Rhode Island coastline, to achieve a higher resolution of 30-100 m in coastal areas (Torres *et al.* 2018). The high resolution nearshore Cartesian grid (Figures 1 and 2) is 7 km alongshore by 3 km cross-shore, and rotated 15 deg. counter-clockwise to align the offshore boundary with the coast. The domain is discretized near the dunes with 5m by 10m resolution cells in the cross-shore and longshore directions, respectively, while cell resolution then decreases to 25m by 10m near the offshore boundary.

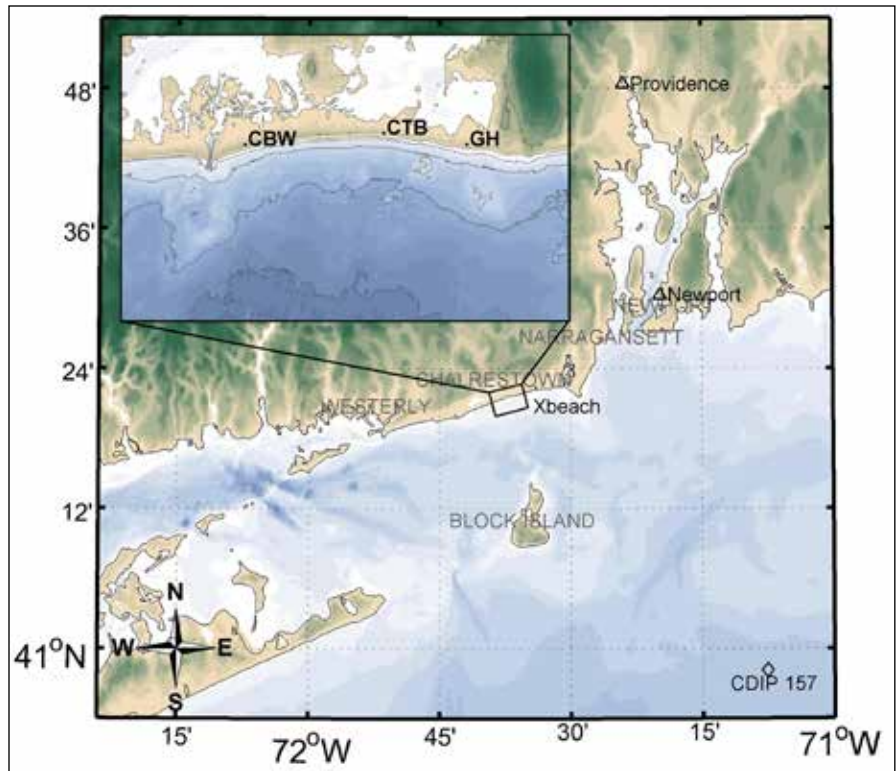

Figure 2. Locations of observational water elevation (triangle), wave (diamond) and transect (dot) data used to validate the regional and nearshore models. The zoomed region within the domain shows the XBeach model domain. The location of the beach profile surveys at Charlestown Breakwater, Charlestown Beach, and Green Hill Transects are also shown (CBW, CTB, GH).



Figure 3. Aerial photo of Ninigret and Quonochontaug Ponds, view toward the west, after Hurricane Carol (1954). Credit Rhode Island Coastal Resources Management Council.

Topographic and bathymetric data were interpolated over the model grids, from NOAA's Montauk 1/3 arc-second (about 10 m) and Northeast Atlantic 3 arc-second (about 90 m) DEMs (Digital Elevation Models; NGDC 2007). For the nearshore grid, topographic data was replaced by higher resolution LiDAR datasets extracted from NOAA's data access viewer (collected in March 2011 and extracted from USGS' LiDAR of the Northeast; OCM Partners 2018a).

CASE STUDY AREA

The primary focus of the study is a 3.5-km-long section of the Charlestown,

RI, coastline (Figure 1), which is overlapped by the nearshore grid. The main area of interest is a stretch of barrier beach located between Green Hill and the Charlestown Breachway, which protects the eastern portion of Ninigret Pond, the coastal lagoon onshore of the barrier (Figure 2). The beach morphology along this stretch of the southern RI coast has been monitored biweekly in winter to monthly in summer since the early 1960s. Measurements of the subaerial beach topography were made along 8 beach transects using a stadia-style technique (The location of three of these transects are shown within the XBeach model domain in Figure 2). This dataset thus provides a time-series of beach profiles, which can be used to estimate volumetric changes (see e.g. Schambach *et al.* 2018). In this work, we selected this section of coastline due to the availability of beach profile data, which can be used for model calibration/validation. The maximum dune crest elevation in this area is 3 m to 5 m NAVD88. The dunes have been breached during significant storms, such as hurricane Carol (Figure 3), and the Great Hurricane of 1938, when the storm surge in Newport, RI, was measured at 3.5 m NAVD88.

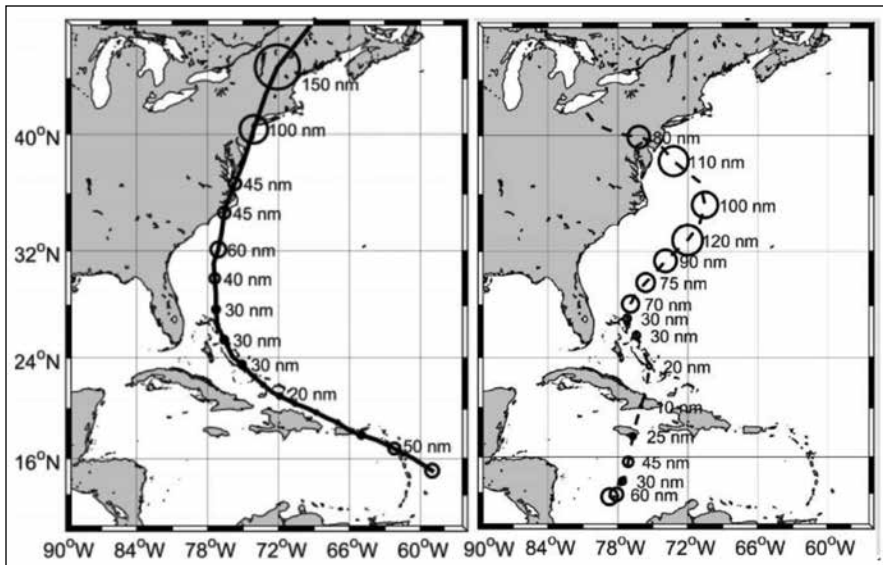
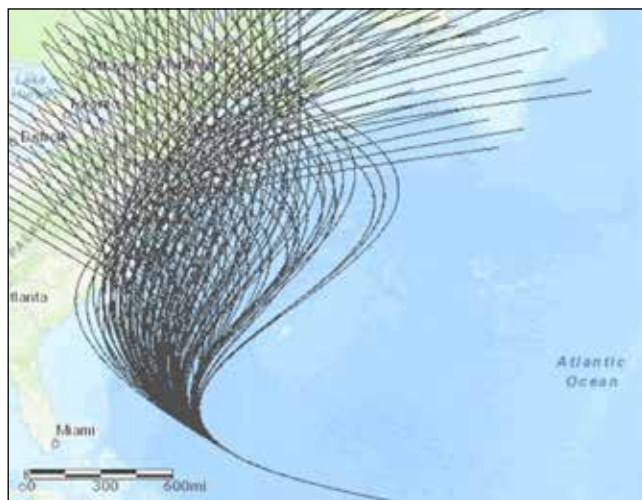

Figure 4. Hurricane Tracks and radii of maximum winds for Hurricanes Irene (left), and Sandy (right).

Figure 5. Tracks of the 1050 synthetic storms used in the NACCS study (Cialone et al. 2015).



MODELING DATA

Historical and synthetic storms

Hurricanes Irene (2011) and Sandy (2012) were used for validation and calibration, respectively, of the SWAN-ADCIRC and the XBeach models. Damages caused by Hurricane Irene were the costliest of the 2011 tropical storm season (Avila and Cangialosi 2011). It formed on 21 August 2011 and reached Category 3 before making landfall in North Carolina as a Category 1 storm. Hurricane Sandy, also known as “Superstorm Sandy,” was the second costliest hurricane in terms of damage to ever hit the U.S. until 2017 when Hurricanes Harvey and Maria surpassed the damage cost of previous hurricanes. Sandy formed on 22 October 2012 in the Caribbean and interacted with another storm system before making landfall in New Jersey on 29 October (Blake et al. 2013). The tracks and radii of maximum winds for these two storms are shown in Figure 4. After modeling these two historical storms, two NACCS storms

(Nadal-Caraballo et al. 2015; Cialone et al. 2015) will be simulated, that were extracted from the set of 1,050 synthetic tropical storms (see Figure 5) to represent events with return periods of 10 and 20 years in the study area.

Meteorological forcing data

For synthetic storms, wind and pressure fields were generated based on a parametric wind model: tracks and parameters were extracted from the NACCS dataset, and used as input for ADCIRC’s internal parametric Asymmetric Holland model (Holland 1980) to generate the wind fields.

For historical storms, two meteorological datasets were used to force the regional storm surge and wave models, which were chosen based on availability and accuracy, depending on the historical hurricane of interest: (1) the NECOFS-WRF (Northeast Coastal Ocean Forecasting System-Weather Research and Forecasting) wind dataset was used for

Sandy, data is provided in three nested domains of increasing resolution from 27 km to 3 km. Note, the hindcast of Hurricane Sandy includes a synthetic (bogus) vortex to improve the predictive accuracy near the storm center (pers. comm C. Chen 12 Jan. 2017). The ECMWF (European Centre for Medium Range Weather Forecast) ERA-interim dataset was used for Irene (the WRF dataset did not include this event). ECMWF is based on a global circulation model and is publicly available for weather reanalysis (Dee et al. 2011) at 1/8-degree spatial resolution, with 3-hour time resolution were used for this meteorological forcing dataset.

Observed hydrodynamic and beach erosion data

Figure 2 shows the location of offshore wave observation buoy, CDIP 157 buoy (cdip.ucsd.edu), and Newport and Providence, RI, NOAA water elevation gauges. These stations were used to validate the regional SWAN-ADCIRC model. The University of Rhode Island has collected beach profile data at three stations within the area of study, representing one of the world’s longest continuous records of beach profiles, dating back as far as the early 1960. Data is sampled twice monthly in the spring, winter, and fall, and monthly during the summer. Eroded volume along the transects located at Charlestown Breachway, Charlestown Beach, and Green Hill Beach (CBW, CTB, and GH in Figure 2) is compared to the calculated erosion in the XBeach model. Additionally, grain size distributions, which were obtained from sediment samples taken at a number of locations by URI students along the beach, were used as input to XBeach.

MODEL CALIBRATION AND VALIDATION

Figure 6 shows a flowchart of the modeling process, and the data that are passed among models. XBeach model settings are summarized in Table 1.

For validation of the regional model results, predicted water elevations were compared with those collected at Newport and Providence, RI, tidal gauges; the wave parameters which were extracted from the nearest node to CDIP 154 Station (Figure 2) were compared to wave height observations. To force the XBeach model during storm conditions, time series of the two-dimensional wave spectrum, and water elevation were ex-

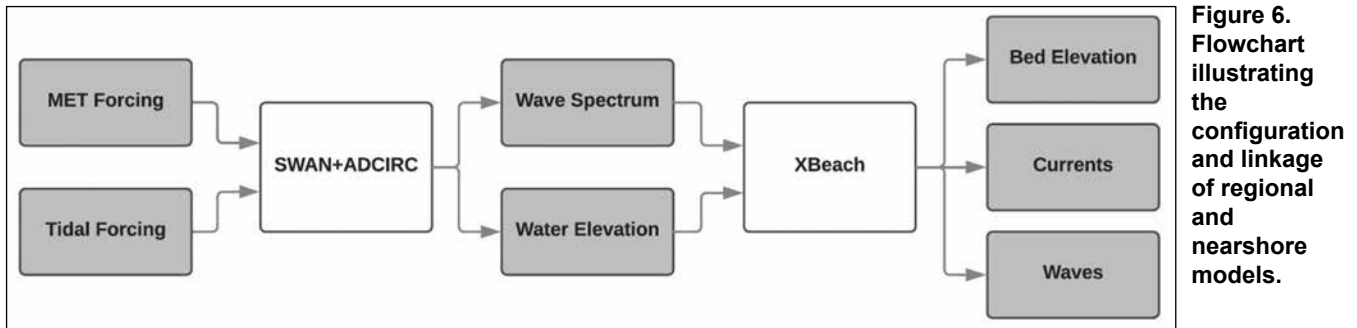

Figure 6. Flowchart illustrating the configuration and linkage of regional and nearshore models.

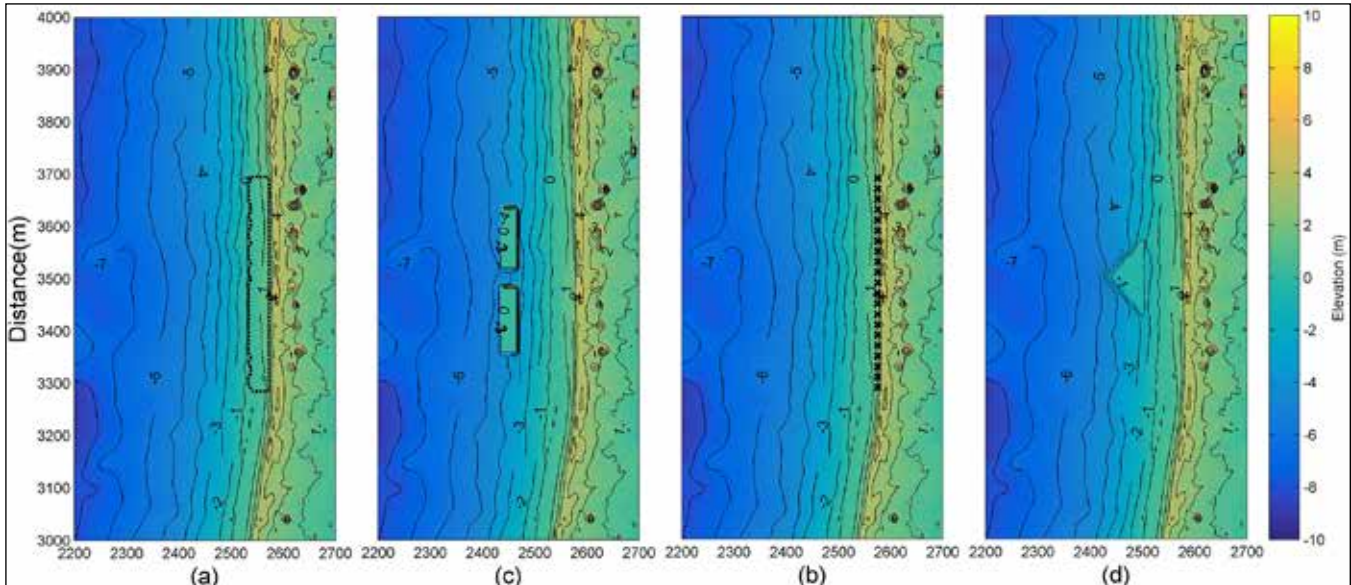

Figure 7. Illustration of four conceptual designs for living shorelines that were simulated in the XBeach model: (a) beach nourishment; the region of beach that has been restored is shown with the dashed line; (b) coastal bank protection; the location of the engineered core is shown with cross marks; (c) living breakwater (green rectangles); and (d) the recreational surfing reef; the green triangle, which is shown with the crest elevation of -1m NADV88.

tracted and implemented at the offshore boundary of the XBeach model domain. Hurricanes Irene and Sandy were both used to validate the coupled SWAN-ADCIRC model.

Sediment transport models generally have higher uncertainties in relation to hydrodynamic models; therefore, XBeach should be calibrated before validation. The goal of the calibration process is to tune the model parameters that are subjected to uncertainties and site specific (e.g. friction coefficients, wave asymmetry) to increase the accuracy of the model predictions. Parameters that have been calibrated in the previous XBeach applications at the site or at similar sites include the *facua* (an onshore sediment transport parameter used to counteract wave asymmetry), Manning friction coefficient, and the Shields parameter. McCall *et al.* (2010) calibrated an XBeach model in the Gulf of Mexico by tuning Shields parameter values. De Vet *et al.* (2015) and Nederhoff *et al.* (2015) showed that a *facua* parameter of 0.25 was best to

Table 1. Summary of XBeach model parameter values.

Variable	Value	Description (& units, if applicable)
Wave Hydrodynamics	Surf-Beat	Wave forcing option: waves are phase averaged, wave groups are resolved.
Morfac	5	Morphological acceleration factor used to decrease computation time by reducing frequency of bottom-updating.
Dtbc	2	Boundary wave flux updating frequency (seconds)
Rt	3600	Frequency at which XBeach will read new wave spectrum (seconds)
Facua	0.15-0.35	Asymmetric onshore sediment transport to parameterize wave asymmetry
Tsmin	0.1	Minimum time step in advection-diffusion equation (seconds)
Wave forcing	SWAN 2-D spectrum	Wave boundary conditions
Water level forcing	ADCIRC	Water elevation forcing for offshore boundary
Friction	Manning (0.02)	Bottom friction formulation

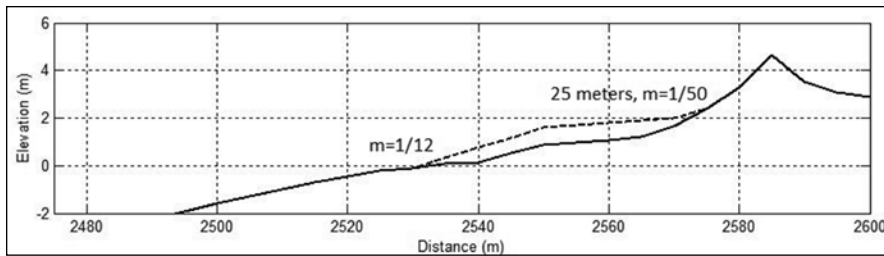

Figure 8. A transect showing the beach nourishment conceptual design. The dashed line shows the replenished beach face; slopes(m) of the beach face and foreshore face are shown.

simulate the erosion during Hurricane Sandy in Fire Island, NY, and Bay Head, NJ, respectively. Additionally, Schambach *et al.* (2018) used a *facua* parameter of 0.3 at the current study's site to obtain the best agreement with observations during Tropical Storm Irene. Elsayed and Oumeraci (2017) showed that the *facua* parameter can reliably be defined as a function of the beach slope.

To evaluate the performance of the XBeach model, changes in the beach profiles after two major historical hurricanes were examined. Observed beach profile data did not extend far offshore, meaning the observed transect data could only be compared from the shoreline to the dunes. Additionally, the transect data before each storm were not taken at the same time as the LiDAR data was collected (note that the initial topographical/bathymetric elevation in the model runs was based on LiDAR data and not the 1-D transect data).

Therefore, the collected data were not sufficient to validate elevation changes along the profiles in the model. Consequently, the eroded volume was used to compare the erosion in the XBeach model against observed erosion as an approximation as done in Schambach *et al.* (2018). Hurricane Sandy was used to calibrate the XBeach model using *facua* parameters ranging from 0.15 to 0.35. For validation, Hurricane Irene was simulated using the *facua* parameter that provided the best results in the calibration stage. Calculated eroded volumes were compared to observations at the Charlestown Breakwater (CBW), Charlestown Beach (CTB), and Green Hill (GH) Transects (Figure 2).

In addition to the qualitative validation, differences in elevations between the April 2011 USGS LiDAR and the October 2012 USACE Post Sandy LiDAR (OCM Partners 2018b) were used to compare the spatial variation of erosion in the model

with observed dune and beach profile changes (<https://coast.noaa.gov/>).

SIMULATION OF LIVING SHORELINE PROPOSED SOLUTIONS

The XBeach model was used to analyze the performance and effectiveness of coastal erosion mitigation methods. A recent study in New England (US) by Woods Hole Group (2017) recommended several living shorelines to address beach/dune erosion. These methods included beach nourishment, coastal banks-engineered core, dune-engineered core, living breakwaters, and marsh creation. Here, three of those methods, appropriate for the area of interest were examined. Additionally, a recreational surfing reef was also examined as a method that may have a potential in areas that are used for surfing (Innes 2005).

Four conceptual designs were implemented in the XBeach model to examine the response of the beach to living shoreline methods (see Figure 7). We must emphasize that a practical design needs much more analysis considering the benefit-cost, environmental impacts, and comparison of several design variants (e.g. dimensions) in terms of the technical performance. A detailed engineering design is beyond the scope of this paper; therefore, each proposed living shoreline is a conceptual design. The living elements (i.e. dune vegetation, sea grass, geotextile fabric) within the conceptual methods are not modeled in XBeach. Simulations are meant to conceptually show how coastal erosion is alleviated during a storm by each method. They are not intended to provide a final design.

Method 1: Beach nourishment

To simulate a replenished beach, the elevation of the berm and foreshore were increased for a section of the XBeach model. The beach face was extended 25 m seaward from an existing 2 m elevation (NAVD88) point with a 1/50 slope.

A 1:12 beach slope was used to tie-in the replenished beach face with the existing beach elevation. A transect within the XBeach domain, shown in Figure 8, illustrates the implementation of the hypothetical beach nourishment. The mean volume of sediment needed for this replenishment design was 25.5 m³/m. Figure 7a illustrates the regions where the elevation in the XBeach model was increased, representing the extent of the beach restoration.

Method 2: Coastal bank protection — engineered core

An Engineered Core-Coastal Bank uses geotextile tubes to support the toe of a coastal dune system. This will simultaneously protect the toe of the dune from scour during storms, while providing support for the rest of the dune. To simulate an engineered core coastal bank, a non-erodible layer was implemented at the toe of the dune in the XBeach model. The non-erodible layer is shown as the shaded region in Figure 7b.

Method 3: Living breakwater

A living breakwater is designed to break waves on nearshore rather than on the shoreline to mitigate erosion. A living breakwater have the potential to improve habitat. Pre-cast reef balls are one example (e.g. see Woods Hole Group 2017). A submerged living breakwater was simulated in the XBeach model by creating a non-erodible reef approximately 100 m offshore. The reef can be seen in Figure 7c, and consists of two 100-m segments. The elevation of the crest is 0.0 m NAVD88. A non-erodible layer was applied over the reef to prevent erosion of the reef.

Method 4: Recreational surfing reef

Recreational geotextile breakwaters have also been designed for combined recreational use and erosion mitigation. For instance, Mendonça *et al.* (2012) proposed an artificial reef with an angle of 45 degrees which would create wave peel angles suitable for advanced surfers. The reef, shown in Figure 7d, has a crest depth of -1 m NAVD88, and dimensions of 75 m and 100 m in the cross-shore and longshore directions, respectively. The reef is located approximately 50 m offshore from the shoreline. The sides have a slope of -3/50 and decrease until the local bathymetry is greater than the elevation of the reef.

Two synthetic storms were selected with return periods of 20 years and 10

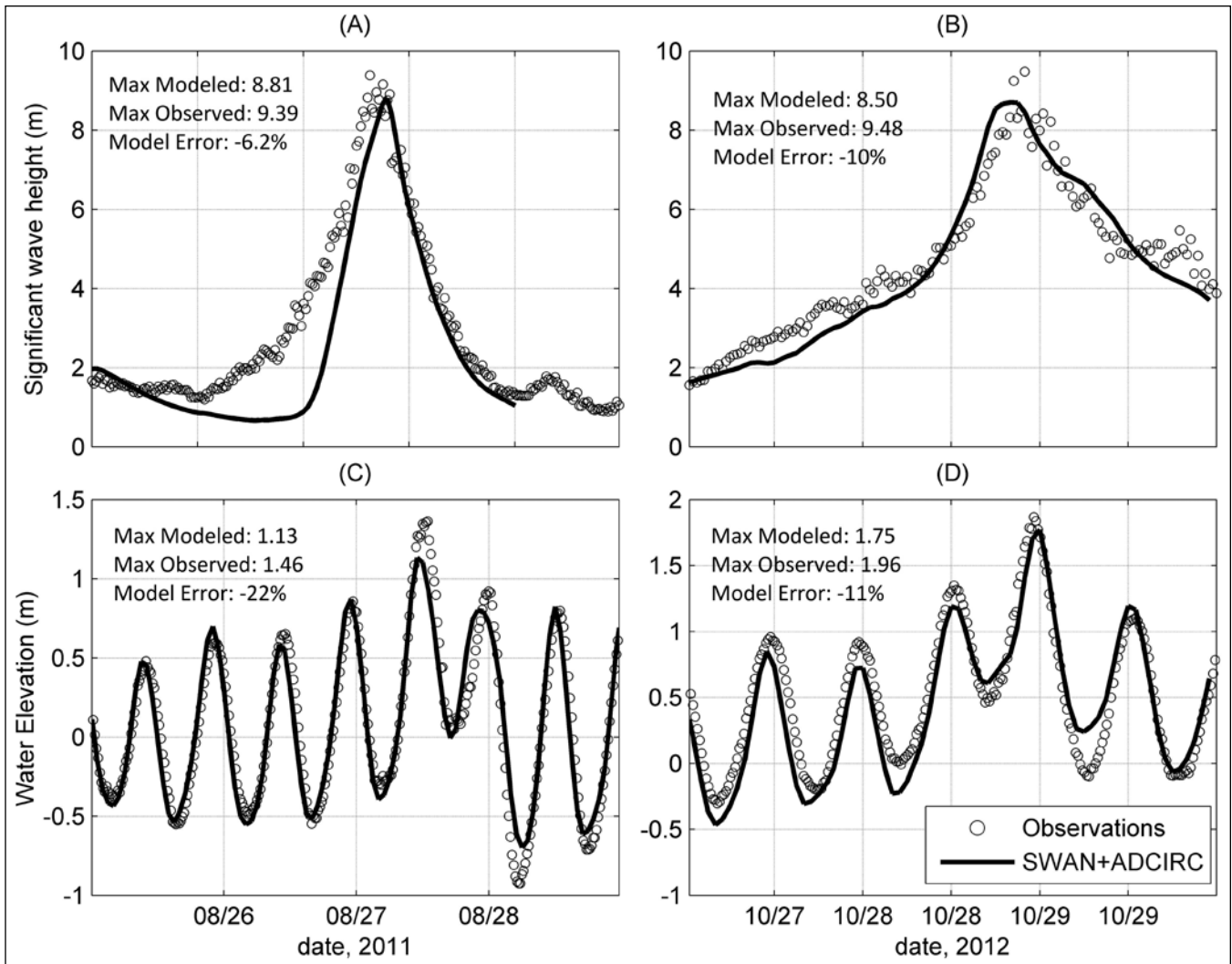

Figure 9. Validation of the SWAN-ADCIRC regional model. Model results were compared to observed offshore wave heights at CDIP 154 wave buoy, and water elevation data at the Newport water level gauge. A and C show the results for Hurricane Irene, and B and D show the results for Hurricane Sandy. Peak modeled and observed water elevations and wave heights along with errors are shown in each.

years. Such short return periods correspond to a relatively high risk of occurrence, of 5% and 10% annually respectively. These return periods are sometimes used for the design of living shorelines. For instance, Woods Hole Group (2011) performed a beach nourishment study at nearby Narragansett Town Beach, using 10- and 25-year return periods. Additionally, geosynthetics generally require maintenance of around 25 years after installation (Greenwood *et al.* 2012). Due to the shorter lifetime of living shorelines, it is unreasonable to design them for very strong storms such as 100-year storms.

To select the synthetic storms, peak water elevations of the NACCS storms at a save point near Charlestown, RI, nearest to the XBeach model origin were compared with NOAA's water level exceedance probability curves estimated at Newport (Figure 2). This assumption is

acceptable because extreme water levels at both locations are similar during extreme events (Hashemi *et al.* 2016). Storm surge and waves were simulated using the coupled SWAN-ADCIRC model for the selected synthetic storms. The synthetic storms were simulated without tides, and a tidal signal was added to the resulting storm surge. This tidal signal was shifted to tune the peak water levels and the predicted return period (1.62 m and 1.78 m NAVD88 for the 10- and 20-year storms, respectively).

Since the meteorological forcing (i.e. wind speed and pressure field over the entire domain) were not provided in the NACCS database, the wind field was recreated using the selected storm's tracks and parameters and ADCIRC internal Asymmetric Holland model. To check that this method is consistent with the original NACCS wind field, the time

series of wind speed and pressure were compared with those from a NACCS save point near the XBeach model domain; the differences were small and acceptable.

XBeach was forced at the offshore boundary with wave spectral parameters and surge elevations, without the consideration of SLR. In addition to a control or baseline simulation (no living shoreline), simulations were performed for each of the four erosion control methods and for the two synthetic storms (10- and 20-year return periods), resulting to a total of 10 simulations. For each scenario, the effectiveness of the proposed mitigation measure was assessed using two metrics: the eroded foreshore volume and the eroded dune volume. These variables were compared with a control simulation in which no mitigation measure was implemented. The foreshore eroded volume is calculated seaward of the 2 m

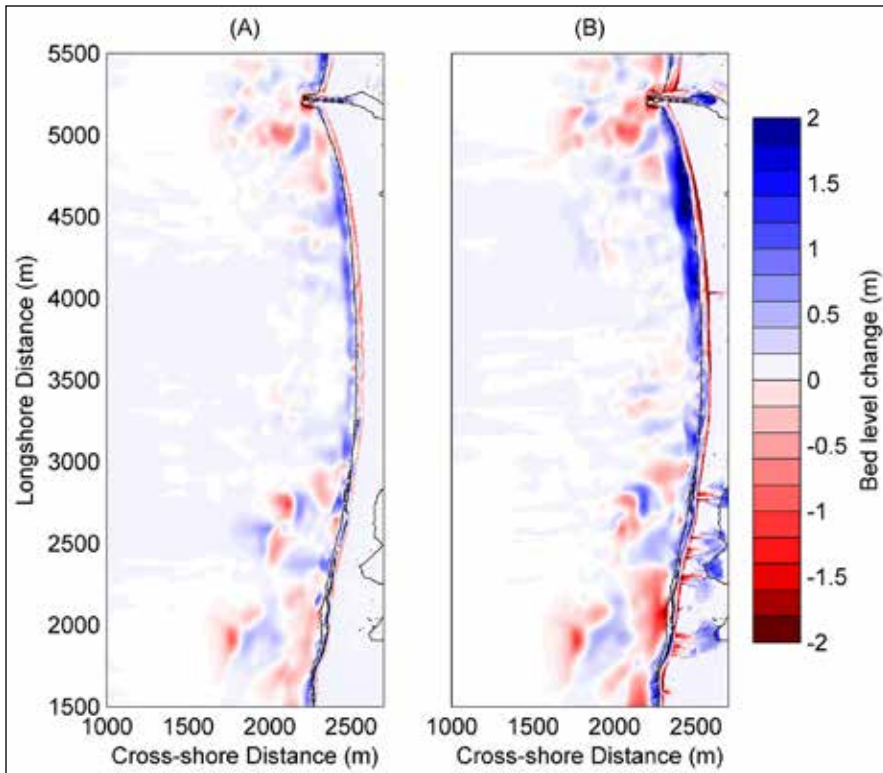
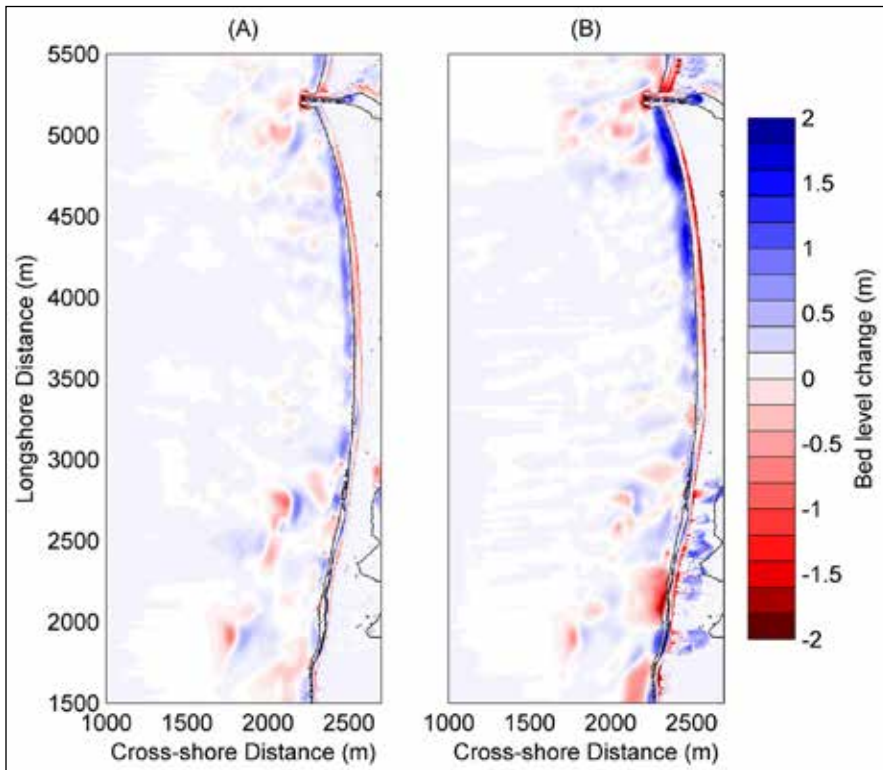

Figure 10. Simulated bed level change for Irene (A) and Sandy (B), with $facua=0.25$. Red shaded areas illustrate erosion, while the blue shaded regions show deposition.

Figure 11. Simulated bed level change for NACCS # 551 (A; 10-year) and #377 (B; 20-year), with $facua=0.25$. Red shaded areas illustrate erosion, while the blue shaded regions show deposition.



(NAVD88) elevation contour, while the eroded dune volume is calculated over the entire dune.

RESULTS AND DISCUSSION

Model calibration and validation

Regional and nearshore model (SWAN-ADCIRC) results were compared with observed significant wave height, and water elevation data for two selected historical storms. Figure 9 compares the observed water elevations and significant wave heights (circles) with those predicted by the model. Peak water elevations and wave heights were also compared. The result show a convincing model performance for wave height (less than 10% peak error, as shown in Figure 9). The estimated peak water elevation in Irene is underestimated, while the model shows better agreement for Hurricane Sandy.

Erosion data during Hurricane Sandy were used to calibrate XBeach. Figure 10b shows the estimated bed level change during Hurricane Sandy. The volume of erosion was only compared along the Charlestown Beach (CTB) and Green Hill (GH) transects, as storm surge and waves had washed out the reference stakes for the Charlestown Breachway (CBW) and Green Hill during this storm. The Green Hill stake was replaced, but the Charlestown Breachway transect was decommissioned. The model calibration results in a value of the $facua$ parameter of 0.25 corresponding to a minimal value of the mean error, defined as the mean of the relative error in absolute value (Table 2).

Hurricane Irene was used for validation, simulated eroded volume are compared with volume changes based on surveyed profiles and are summarized in Table 3. Irene was a less severe and a faster moving storm, resulting in significantly less erosion in comparison to Sandy. Dune overtopping was not observed within the XBeach domain for the duration of the simulation, meaning the storm only entered the collision regime (De Vet *et al.* 2015). Table 3 summarizes the results of the XBeach model validation, the observed and modeled eroded volumes (m^3/m) are compared for each transect. The mean error along modeled transects was 23%.

PERFORMANCE OF LIVING SHORELINE MITIGATION MEASURES

Before examining the living shoreline solutions for erosion mitigation, a con-

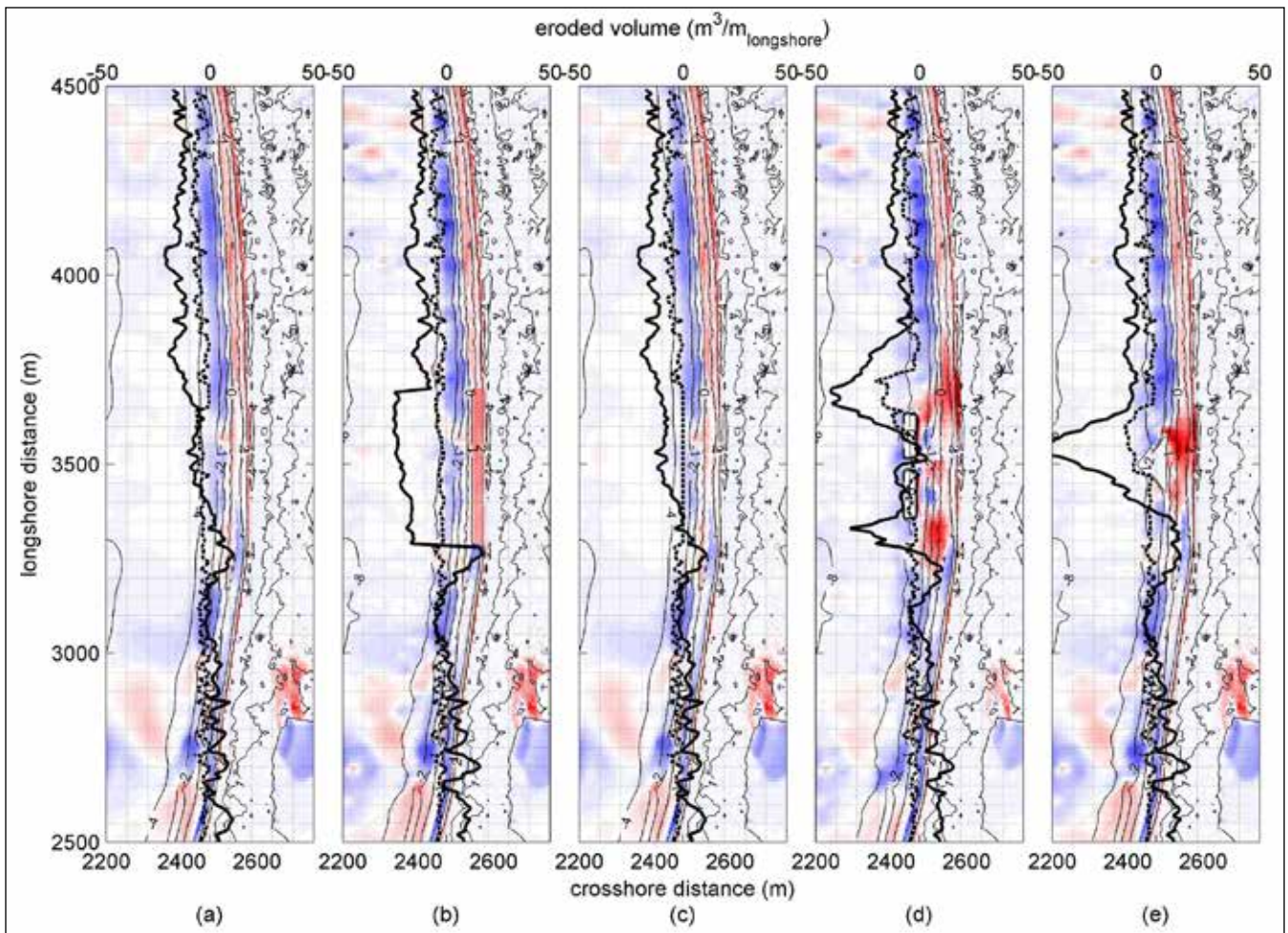

Figure 12: Close-up views of the bed level change during the 10-year storm (NACCS #551) for the control run (a), and four erosion mitigation methods: beach nourishment (b), coastal bank (c), living breakwater (d), and recreational surfing reef (e). Shading illustrates magnitude of elevation change, cross-hatched areas show deposition. The longshore variation of foreshore (solid-dot), and dune volume change (dashed) are plotted over the erosion plots. The left and bottom axes correspond to the longshore and cross-shore distances, respectively, the top x-axis corresponds to m^3/m of volume change.

control run for each storm was simulated in which no mitigation measure was implemented in the area. The bed level change during the control simulations for the 10-year (NACCS Storm #551) and 20-year (NACCS Storm #377) storms can be seen in Figure 11. These two synthetic storms were of similar magnitudes to Hurricanes Irene and Sandy. Like Hurricane Irene, NACCS 551 caused minimal dune erosion and scour. NACCS 377 entered the over-wash regime, overtopping the dunes, and caused over-wash fans in the southern portion of the domain as shown in Figure 11.

After performing the control simulations, the conceptual mitigation measures were simulated for each storm. Figures 12 and 13 show the initial elevation contours, and bed level change as a result of the 10- and 20-year storm simulations, respectively. The resulting bed level changes are shown for the control sce-

nario (i.e. no living shoreline), and four erosion mitigation measures. Additionally, the longshore variability of both the eroded berm volume (m^3/m), and eroded dune volume (m^3/m) are shown with the bold solid and dashed lines, respectively. The eroded volumes were computed by comparing the cross-shore profiles before and after each storm. The mean and maximum erosion for these parameters are summarized in Table 4.

In the control run (Figures 12a and 13a), berm and dune erosion rates were higher near longshore station 4000, and decreased heading in the direction of station 3000 for both storms. Referring to Table 4, for the control scenario, the mean eroded berm volume (m^3/m) during the 10-year storm was $5.1 m^3/m$, with a maximum of $20.1 m^3/m$. The mean eroded dune volume was $3.3 m^3/m$, and the maximum was $7.5 m^3/m$. The 20-year storm caused less berm erosion ($3.9 m^3/m$

[mean], $18.1 m^3/m$ [max]), and higher dune erosion ($16.7 m^3/m$ [mean], $32.6 m^3/m$ [max]) in comparison.

In terms of living shorelines, Method 1 (beach nourishment; Figures 12b and 13b) resulted in increased erosion of the berm, as shown by the solid line between stations 3250 and 3750, likely due to the increased shoreline volume. This increased berm erosion ($11.1 m^3/m$ [mean] for both the 10- and 20-year) is significantly higher than the rates observed in the control run. The increased berm size protected the dunes, resulting in lower mean eroded volumes for both the 10- and 20-year storms ($3.2 m^3/m$ [mean 10-year], $13.9 m^3/m$ [mean 20-year]).

Method 2 (coastal bank protection; Figures 12c and 13c) also resulted in increased erosion of the berm, but to a lesser degree than Method 1. As shown by the solid line in Figures 12c and 13c,

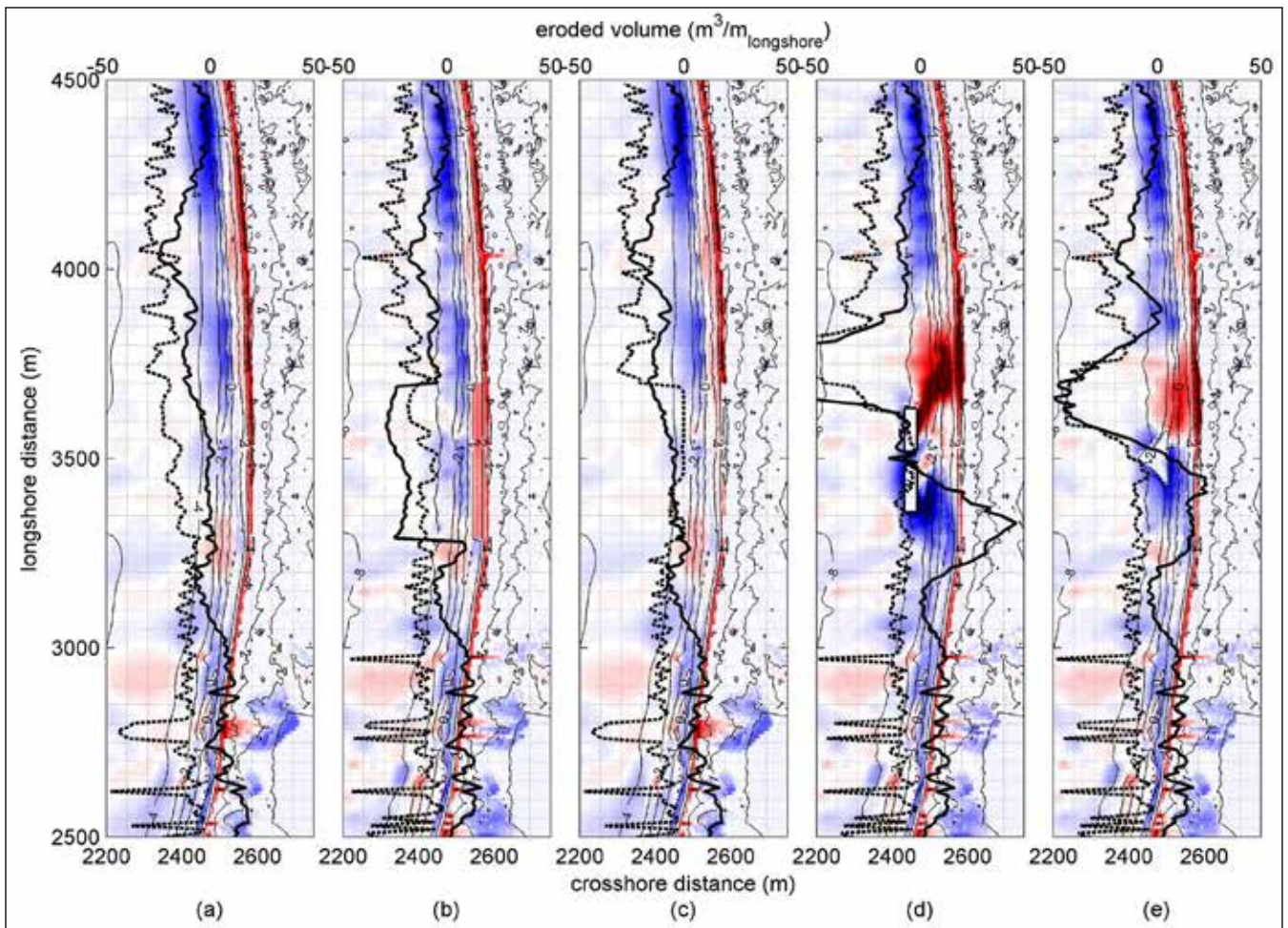

Figure 13. Close-up views of bed level change during the 20-year storm (NACCS #377) for the control run (a), and four erosion mitigation methods: beach nourishment (b), coastal bank (c), living breakwater (d), and recreational surfing reef (e). Red areas show erosion, while blue areas show deposition. The longshore variation of foreshore (solid), and dune volume change (dashed) are plotted over the erosion plots. The left and bottom axes correspond to the longshore and cross-shore distances, respectively; the top x-axis corresponds to m^3/m of volume change.

the trend more closely follows that of the control run (Figures 12a and 13a). The slight increase of the berm erosion ($6.0 m^3/m$ [mean 10-year] and $6.1 m^3/m$ [mean 20-year]) is significantly higher than the rates observed in the control run. For the dunes, significantly lower mean eroded volumes for both the 10- and 20-year storms were observed [$1.8 m^3/m$ (mean 10-year), $10.2 m^3/m$ (mean 20-year)].

Methods 3 and 4 (living breakwater, surfing reef; Figures 12d-e and 13d-e) both cause significant spikes in both berm and dune erosion while some protection in the lee of breakwater can be seen. In Figure 12d, two regions of increased erosion are observed on either side of the living breakwater, while only the area directly behind the structure is protected. In Figure 12e, as the surfing reef accelerated the berm and dune ero-

sion in the lee of the structure. During the 10-year storm, both structures resulted in significant accretion of sediment to the east of the structures (bottom in Figures 13d-e). In Figure 13d, a large spike of berm and dune erosion was observed to the west (top) of the structure, a spike in berm accretion occurred on the opposite side of the structure, but to a lesser degree. In Figure 13e, a similar pattern was observed, but of a lesser magnitude. The mean eroded berm and dune volumes in Table 4 were inconclusive for these two cases; as areas of accumulated sediment in the berm counteracted the eroded volume.

Table 2.

XBeach simulated eroded volume (m^3/m) during Hurricane Sandy for transects CTB and GH for varying Facua values, used for model calibration. Percent errors ($((\text{modeled}-\text{obs})/\text{obs})\times 100$) are shown in parentheses.

Location of transect	Observed	Facua Parameter Value			
		0.15	0.20	0.25	0.30
CTB	32.72	78.42 (+139%)	67.39 (+105%)	36.93 (+13%)	45.24 (+38%)
GH	81.63	80.38 (-1.5%)	60.34 (-26%)	54.73 (-33%)	54.88 (-32%)
Mean absolute error	70.58%	66.01%	22.90%	35.51%	

DISCUSSION

The regional model showed good agreement with both wave height and water level observations during Hurricane Sandy. For Hurricane Irene, the prediction of significant wave height was less than 10% at the CDIP buoy, but the

Table 3.

Observed versus modeled eroded volumes (m^3/m) along three transects within the XBeach model for Hurricane Irene. Percent error along each transect are shown in the parentheses.

Location of transect	Observed (m^3/m)	Modeled (m^3/m)
CBW	18.53	14.39 (-22%)
CTB	24.18	26.02 (+8%)
GH	21.89	13.28 (-39%)
Mean absolute error	21.53	17.90 (23%)

storm surge was underestimated by approximately 20%. This can be related to the accuracy of wind forcing as a better wind product (i.e. WRF-NECOFS) was available for Hurricane Sandy unlike Hurricane Irene. Torres *et al.* (2018) discussed the sensitivity of regional storm surge models and showed that wind products such as WRF-NECOFS that can simulate both the environmental wind (background winds distant from the storm) and a hurricane structure lead to much more accurate results compared with wind data that are based only on parametric hurricane models.

Hurricane Sandy was chosen to calibrate the nearshore sediment transport model because the storm had a greater impact on the beach. However, the length of beach profiles were not sufficient (in the sea). Further, 2-D models like XBeach need a 2-D DEM before and after the storm for model calibration and validations which were not available in this study. Nevertheless, the eroded volume provided an approximate basis for comparison.

In addition to the quantitative validations of eroded beach volumes at locations of transects, available LiDAR data produced in April 2011 and November 2012 can be used to assess (at least qualitatively) the spatial performance of XBeach. Figure 14a shows the difference in bed elevation between the two LiDAR datasets. Because the LiDAR was not produced immediately after Hurricane Sandy, surge channels that occurred during dune breaching were not as apparent as the results of the simulation, as seen in Figure 14b. However, XBeach was able to simulate where dune elevation had been decreased, and the location of surge channels and over-wash fans.

Table 4.

Maximum and mean beach face (berm) and dune's eroded volume(m^3/m) for each mitigation method shown in Figures 12 and 13.

Simulation	Erosion assessment's location	Eroded volume (m^3/m) 10-yr storm (NACCS #551)		Eroded volume (m^3/m) 20-yr storm (NACCS #377)	
		Max	Mean	Max	Mean
Control	Berm	20.1	5.1	18.1	3.9
	Dune	7.5	3.3	32.6	16.7
Method 1 (Beach nourishment)	Berm	25.4	11.	2.0	11.1
	Dune	7.8	3.2	31.0	13.9
Method 2 (Coastal bank)	Berm	20.3	6.0	19.2	6.1
	Dune	7.4	1.8	31.4	10.2
Method 3 (Living breakwater)	Berm	42.7	10.3	81.1	6.6
	Dune	21.4	4.8	67.2	19.8
Method 4 (Surfing reef)	Berm	60.8	10.6	49.5	4.8
	Dune	14.4	4.7	44.7	18.1

XBeach model slightly under predicted the erosion across the domain, which was most apparent near the boundaries. A possible source of error in the validation stage is the underestimation of storm surge elevation. Further, the spatial coverage of the three transects within the model domain was relatively poor. Figures 12 and 13 show the significance of longshore variability. Therefore, collection of DEM data before and after a major storm can provide a much better basis for calibration and assessment of the XBeach model.

Although the peaks and time series of the significant wave height at the CDIP buoy were similar during Hurricanes Irene and Sandy, Sandy resulted in much more erosion in comparison to Hurricane Irene as a result of higher storm surge. This confirms the importance of combined surge and wave simulations for erosion simulations. Munger and Kraus (2010) were able to classify the return period of erosion during storms using an integrated hydrograph method. They showed that erosion rates were proportional to a combination of surge, wave height, and storm duration.

A major assumption used in simulation of living shorelines was the "non-erodible" layer in XBeach (used for Methods 2, 3 and 4). This method was applied over hard structures (e.g. breakwaters, engineered core), and prevented any erosion for these structures. Although XBeach can simulate scour, the movement and collapse of the structures

themselves cannot be simulated with this methodology. Therefore, the structural properties such as stability, and durability of the proposed mitigation measures were not considered. In addition, the response of the beach during the storm period was examined, and the impact of these living shoreline structures in long term and during calm periods were not simulated. For a comprehensive assessment of living shorelines, these aspects as well as cost, environmental benefits, and local regulations should be considered (e.g. see Bilkovic *et al.* [2017]).

The beach nourishment simulations experienced more berm erosion and less dune erosion during the selected synthetic storms. The increased foreshore erosion is likely due to the increased amount of sediment volume in the berm compared to the control simulation. The increased length of the nourished beach provided more protection to the dunes. The engineered core coastal bank also experienced more berm erosion, and less dune erosion in relation to the control test. The non-erodible layer supported the dunes, but also prevented sediment in the dunes from moving offshore.

The living breakwater and surfing reef simulations significantly impacted the erosion along the shoreline during the storm-scale simulations. The wave direction during the selected 10-year storm (NACCS #551) was relatively perpendicular to the shoreline, and little longshore current was present. Referring to Figure 12, a slight decrease of berm erosion di-

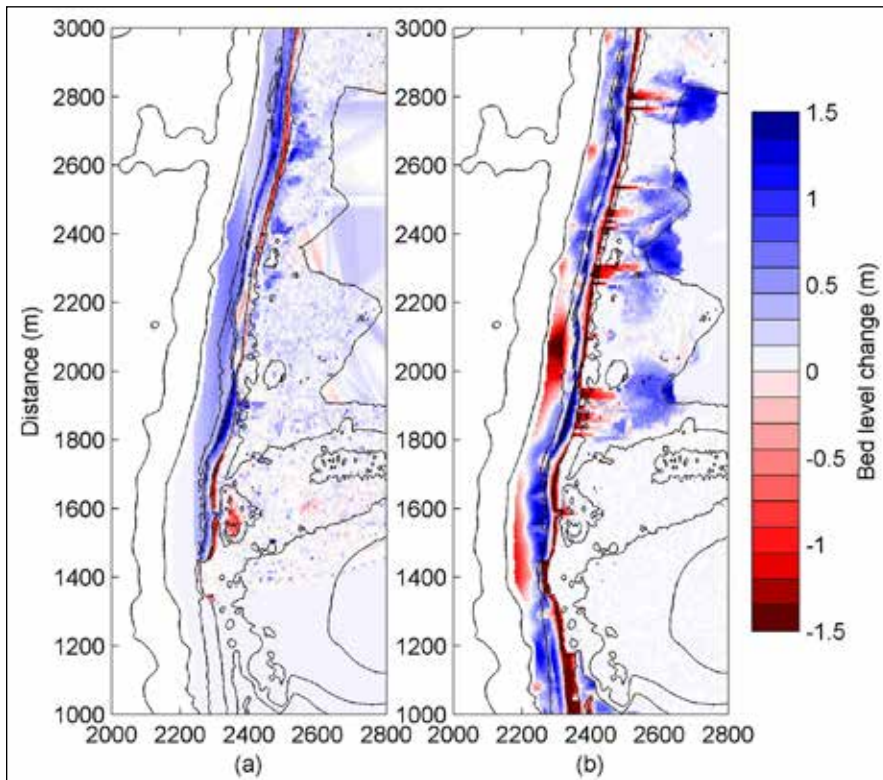

Figure 14. Qualitative comparison of observed (a) (using the difference of DEM in 2011 and 2012) and modeled (b) elevation change.

rectly behind the artificial breakwater is observed, but is dwarfed by the increase of erosion to either side of the structure. An increase of both dune and berm erosion was observed in lee of the surfing reef. During the 20-year storm (NACCS #377), the wave direction was more easterly, resulting in a more prominent East to West longshore current (bottom to top in Figure 13). This longshore current increased the rate of sediment deposition, as well as erosion for both the offshore breakwater, and surfing reef. In both instances, the reduction of wave energy resulted in sediment deposition near the bottom (East) breakwater due to wave breaking. However, this in turn reduced available sediments around the top (West) breakwater, leading to increased erosion. This can be observed in Figure 13d and 13e, an increase of foreshore volume was observed to the east of the structures (bottom), while the rate of erosion was significantly increased to the West (top).

During both storm events, the negative impacts along the shoreline outweighed the positive effects of both the living breakwater, and surfing reef. The effectiveness of these methods is directly controlled by the area that they cover, and they may impact other areas adversely.

Structure depth, scale, distance off-

shore, and other factors could significantly affect the beach response behind these structures, and a more in-depth study would ideally include cost-benefit analyses for projects of multiple scales. It is possible to examine how the performance of a living shoreline method could change with projected SLR scenarios. However, the lifespan of the methods addressed in this paper are short enough that performance changes due to SLR may be neglected.

CONCLUSIONS

A suite of numerical models were used to model erosion during both historical and synthetic tropical storms for a barrier system in RI. The regional hydrodynamic model (SWAN-ADCIRC), covering most of the northeastern United States, was used to calculate water elevations and wave conditions. The two-dimensional wave spectrum and water elevation were then used as offshore boundary conditions for the nearshore hydrodynamic and sediment transport model (XBeach). Surveyed profile data were used to estimate eroded volumes during storms to calibrate and validate the XBeach model. After validation of the modeling system, the performance of several living shoreline methods for erosion mitigation were examined during synthetic 10- and 20-year storm conditions for Charlestown, RI, a typical barrier system. The following

conclusions can be made from this study:

The XBeach model could predict the eroded volume relatively well with errors on the order of 20%. Proper model calibration was the key step in which the *facua* parameter was tuned (using Hurricane Sandy). It was shown that the calibrated model performed well in the validation stage (Hurricane Irene), using meteorological forcing from Hurricane Irene.

The XBeach model was able to assess the performance of three living shorelines methods (beach nourishment, coastal bank protection with engineered core, and living offshore breakwater) as well as a recreational surfing reef to reduce coastal erosion. However, limitations of this model such as inability to simulate the stability and durability of these structures (e.g. engineered core coastal bank) should be noted.

For this case study, which was focused on a barrier system in Rhode Island, methods that improved the beach face and dunes volumes (e.g. beach nourishment) were generally more effective than those that reduced wave action (e.g. living offshore breakwater)

Collection of data before, after, and during storms can provide a much better understanding of the skill of XBeach, or similar models, for living shoreline simulations. These data include, wave and storm surge near the area of interest, DEM before, and after storm, as well as the conditions of these structures. Therefore, traditional beach profile surveys, although useful, but cannot provide sufficient data for implementation of more advanced numerical models.

REFERENCES

- Avila, L.A., and J. Cangialosi, 2011. "Tropical Cyclone Report — Hurricane Irene" (PDF). National Hurricane Center. Retrieved 22 June 2017.
- Blake, E.S., T.B. Kimberlain, R.J. Berg, J.P. Cangialosi, and J.L. Beven II, 2013. "Tropical Cyclone Report — Hurricane Sandy" (PDF). National Hurricane Center. 2013-2-12. Retrieved 22 June 2017.
- Bilkovic, D.M., M.M. Mitchell, M.K. La Peyre, and J.D. Toft, 2017. *Living shorelines: the science and management of nature-based coastal protection*. CRC Press.
- Booij, N., R.C. Ris, and L.H. Holthuijsen, 1999. "A Third-Generation Wave Model for Coastal Regions, Part I, Model Description and Validation." *J. Geophysical Research*, C4(104), 7649-7666.
- Boothroyd, J.C., R.J. Hollis, B.A. Oakley, and R.E. Henderson, 2016. "Shoreline Change from

- 1939–2014, Washington County, Rhode Island." 1:2,000 scale. Rhode Island Geological Survey. 45 maps. Available online: http://www.crmc.ri.gov/maps/maps_shorechange.html (accessed 15 May 2018).
- Cialone, M.A., C.T. Massey, M.E. Anderson, A.S. Grzegorzewski, R.E. Jensen, A. Cialone, D.J. Mark, K.C. Pevey, B.L. Gunkel, T.O. McAlpin, N.N. Nadal-Caraballo, J.A. Melby, and J.J. Ratcliff, 2015. "North Atlantic Coast Comprehensive Study (NACCS) Coastal Storm Model Simulations: Waves and Water Levels." U.S. Army Engineer Research and Development Center, Technical Report. ERDC-CHL-TR.
- Chen, C., R.C. Beardsley, and G. Cowles, 2006. "An unstructured grid, finite-volume coastal ocean model (FVCOM) system." *Oceanography*, 19(1):78-89.
- De Vet, P.L., R.T. McCall, J.P. Bieman, M.J. Stive, and M.V. Ormondt, 2015. "Modelling Dune Erosion, Overwash and Breaching At Fire Island (NY) During Hurricane Sandy." *Proc. Coastal Sediments 2015*. 10.1142/9789814689977-0006
- Dee, D.P., S.M. Uppala, A.J. Simmons, P. Berrisford, P. Poli, S. Kobayashi, U. Andrae, M.A. Balmaseda, G. Balsamo, P. Bauer, P. Bechtold, A.C.M. Beljaars, L. van de Berg, J. Bidlot, N. Bormann, C. Delsol, R. Dragani, M. Fuentes, A.J. Geer, L. Haimberger, S.B. Healy, H. Hersbach, E.V. Hólm, L. Isaksen, P. Kállberg, M. Köhler, M. Matricardi, A.P. McNally, B.M. Monge-Sanz, J.-J. Morcrette, B.-K. Park, C. Peubey, P. de Rosnay, C. Tavolato, J.-N. Thépaut, and F. Vitart, 2011. "The ERA-Interim reanalysis: configuration and performance of the data assimilation system." *Q.J.R. Meteorol. Soc.*, 137: 553–597. doi:10.1002/qj.828.
- Dietrich, J.C., M. Zijlema, J.J. Westerink, L.H. Holthuijsen, C. Dawson, R.A. Luettich, R. Jensen, J.M. Smith, G.S. Stelling, and G.W. Stone, 2011. "Modeling hurricane waves and storm surge using integrally-coupled, scalable computations." *Coastal Eng.*, 58, 45-65.
- Elsayed, S., and H. Oumeraci, 2017. "Effect of beach slope and grain-stabilization on coastal sediment transport: An attempt to overcome the erosion overestimation by XBeach." *Coastal Eng.*, 121. 179–196. 10.1016/j.coastaleng.2016.12.009.
- Greenwood J.H., H.F. Schroeder, and W. Voskamp, 2012. *Durability of Geosynthetics, CUR Building & Infrastructure*. Gouda, the Netherlands, Publication 243.
- Hashemi, M.R., M.L. Spaulding, A. Shaw, H. Farha-di, and M. Lewis, 2016. "An efficient artificial intelligence model for prediction of tropical storm surge." *Natural Hazards*, 82, 471-491.
- Holland, G.J., 1980. "An analytic model of the wind and pressure profiles in hurricanes." *Monthly Weather Review*, 108(8):1212–1218.
- Holland, G., and C.L. Bruyere, 2014. "Recent intense hurricane response to global climate change." *Climate Dynamics*. 42(617). <https://doi.org/10.1007/s00382-013-1713-0>
- Innes, S.I., 2005. "An Overview of Artificial Reefs for Surfing and Sand Retention in California." In *California and the World Ocean 2002: Revisiting and Revising California's Ocean Agenda*, 191-203.
- Jensen, R.E., A. Cialone, J.M. McKee Smith, M.A. Bryant, and T.J. Hesser, 2016. "Regional wave modeling and evaluation for the North Atlantic coast comprehensive study." *J. Water. Ports Coast. Ocean Eng.*, B4016001.
- Luettich, R.A. Jr., J.J. Westerink, and N.W. Schefner, 1992. "ADCIRC: an advanced three-dimensional circulation model for shelves, coasts and estuaries." Report 1. Theory and methodology of ADCIRC-2DDI and ADCIRC-3DL, U.S. Army Corps of Engineers Technical Report DRP-92-6.
- McCall, R., J.V. Vries, N. Plant, A.V. Dongeren, J. Roelvink, D. Thompson, and A. Reniers, 2010. "Two-dimensional time dependent hurricane overwash and erosion modeling at Santa Rosa Island." *Coastal Eng.*, 57(7), 668-683. doi:10.1016/j.coastaleng.2010.02.006.
- Mendonca, A., C.J. Fortes, R. Capito, M.G. Neves, J.S. Carmo, and T. Moura, 2012. "Hydrodynamics around an Artificial Surfing Reef at Leirosa, Portugal." *J. Water. Port. Coast. Ocean Eng.*, 138(3), 226-235. doi:10.1061/(asce)ww.1943-5460.0000128
- Munger, S., and N.C. Kraus, 2010. "Frequency of Extreme Storms Based on Beach Erosion at Northern Assateague Island, Maryland." *Shore & Beach*, 78(2), 3-11.
- Nadal-Caraballo, N.C., J.A. Melby, V.M. Gonzalez, and A.T. Cox, 2014. "North Atlantic Coast Comprehensive Study (NACCS): Coastal Storm Hazards from Virginia to Maine." U.S. Army Engineer Research and Development Center (ERDC), Technical Report. ERDC-CHL-TR-15-5, 2015.
- National Geophysical Data Center, NESDIS, NOAA, U.S. Department of Commerce, 2007. "Montauk, New York 1/3 arc-second MHW Coastal Digital Elevation Model." Retrieved from: <https://maps.ngdc.noaa.gov/viewers/bathymetry/?layers=dem>
- Nederhoff, C., Q. Lodder, M. Boers, J.D. Bieman, and J. Miller, 2015. "Modeling the effects of hard structures on dune erosion and overwash." *Proc. Coastal Sediments 2015*. doi:10.1142/9789814689977-0219.
- OCM Partners, 2018a. "2011 U.S. Geological Survey Topographic LiDAR: LiDAR for the Northeast." Retrieved from: <https://inport.nmfs.noaa.gov/inport/item/49844>.
- OCM Partners, 2018b. "2012 USACE Post Sandy Topographic LiDAR: Rhode Island and Massachusetts Coast." Retrieved from: <https://inport.nmfs.noaa.gov/inport/item/49609>.
- Roelvink, D., A. Reniers, A.V. Dongeren, J.V. Vries, J. Lescinski, and R. McCall, 2009. "Modeling storm impacts on beaches, dunes and barrier islands." *Coastal Eng.*, doi:10.1142/9789814277426-0140
- Shaw, A., M. Hashemi, M. Spaulding, B. Oakley, and C. Baxter, 2016. "Effect of coastal erosion on storm surge: A case study in the southern coast of Rhode Island." *J. Marine Science and Eng.*, 4(4), 85.
- Schambach, L., A.G. Grilli, S.T. Grilli, M.R. Hashemi, and J. King, 2018. "Assessing the impact of extreme storms on barrier beaches along the Atlantic coastline: Application to the Southern Rhode Island coast." *Coastal Eng.*, 133: 26-42.
- Torres, M.J., M.R. Hashemi, S. Hayward, M. Spaulding, I. Ginis, and S. Grilli, 2018. "The role of hurricane wind models in accurate simulation of storm surge and waves." *J. Water. Port. Coast. Ocean Eng.*, 145 (1) doi: 10.1061/(ASCE)WW.1943-5460.0000496.
- Woods Hole Group, 2011. "Narragansett Town Beach Replenishment Feasibility Project." Retrieved from: <http://www.narragansetttri.gov/DocumentCenter/Home/View/782>.
- Woods Hole Group, 2017. "Living Shorelines in New England: State of the Practice." Retrieved from: https://www.conservationgateway.org/ConservationPractices/Marine/crr/Documents/Final_StateofthePractice_7.2017.pdf.
- Yoshida, K., M. Sugi, R. Mizuta, H. Murakami, and M. Ishii, 2017. "Future changes in tropical cyclone activity in high-resolution large-ensemble simulations." *Geophysical Research Letters*, 44(19), 9910-9917.
- Zeitlin-Hale, L., S.B. Olsen, and M. Grant, 2010. "The State of Rhode Island Coastal Resources Management Program, as Revised." Providence, RI: Coastal Resources Management Council.

FIRST Coastal
631.288.2271
firstcoastal.com

Environmental Consulting
Beach & Coastal Restoration
Marine Contracting
LONG ISLAND, NY - CARIBBEAN SINCE 1975

COMPLETE COASTAL ENGINEERING SERVICES

ATM | DESIGN ENGINEERING CONSULTING
APPLIED TECHNOLOGY & MANAGEMENT, INC.

561.659.0041
www.appliedtm.com

Coastal, Environmental, Marine & Water Resources Engineering

- Nourishment Feasibility, Design & Permitting
- Economic Analysis & Cost Allocation Plan
- Shoreline Stabilization & Coastal Structures
- Coastal Hazard/FEMA Specialists
- Complete Marina & Waterfront Development Services